



SERVICE PARTS CATALOG

Your Guide to Service Replacement Parts
for NKL and Gary Safes



PARTS BOOK

How to Order: To place an order call Fire King Security Products at 1-800-528-9900, extension 611, or you may fax your order to 1-800-227-7513 (please provide shipping information). You may also e-mail your order to parts@fireking.com (please provide shipping information).

Requirements: 1) The Parts Sales Department is setup for the sale of out of warranty service parts. If you are servicing a safe that is under warranty, please direct your order to Technical Services Department (800-452-4655).

2) To place an order with Fire King Security Products Parts Department, you must have an open account or pay by credit card. Open account requires a minimum of \$100.00 purchase. Credit card purchases do not have a minimum.

Core Charges: A core charge may be applied, for the return of selected used parts, at the discretion of Fire King Security Products Parts Department. An ARS label is shipped with the product to cover return shipping charges on old parts. **Note: If applicable, the "Core Charge Return Form" is shipped with the parts and must accompany the identified part(s) when returned. If the form is not included, credit will not be issued.**

Warranty: A 90 day warranty (parts only) is applied to parts for manufactured defects only. Customer negligence, abuse, or acts of God are not covered. A 15% restocking fee may be applied for all return shipments. To return a defective part, please contact Fire King Security Products at 1-800-528-9900 ext. 611 and identify the defect. All defective warranty parts will be issued a return material authorization (RMA) by Fire King and a call tag number. This will be used to pick up and return the defective product for evaluation. Return shipment will not be accepted unless authorized (RMA) by Fire King. This includes items that are being returned (shipped freight prepaid) and subject to a restocking fee. Fire King Security Products reserves the right to have its representative inspect any product or part to honor any claim. At this time credit will be processed, if applicable. Returns ship to:

Fire King Security Products
101 Security Parkway
New Albany IN 47150

Shipping: All parts are shipped UPS Ground unless otherwise specified. Shipping and handling charges are applied to all orders. Prices vary depending on weight, destination, and shipping method (UPS Ground, UPS 2nd Day Air, or UPS Next Day Air).

©2001 Fire King International Inc.
First Printing: February 2001
Last Revised: September 2001

CONTENTS

SECTION	PAGE
Audit Verification Lock	1
AuditLok XL	2
AuditLok XLV Electronics Package: D8C/D8R	4
AuditLok XLV Electronics Package: D8X	5
AuditLok XLV Electronics Package: V1C	6
AuditLok XLV Electronics Package: V1R	7
AuditLok XLV Electronics Package: V2C	8
AuditLok XLV Electronics Package: V2R	9
AuditLok XLV Electronics Package: AXC/AXR Intellisafe	10
Autobank: 27 Series	11
Auditor Series Autobank Common Electronics	12
Auditor Series Autobank Power, Door, Cable, Vending	13
Auditor Series Autobank Vending, Printing, Validating	14
Sherlock Package	15
TimeLok XL Package	16
Vindicator 1 Package	17
Vindicator 2 Package	18
Digital Keypads	19
Dial and Key Locking Components	20
NKL 3-Series (Meilink CashVault) Mechanical Assemblies	21
NKL Premium (Intellisafe) Mechanical Assemblies	22
NKL D8 Autobank Mechanical Assemblies	24
NKL V1 Autobank Mechanical Assemblies	25
NKL V2 Autobank Mechanical Assemblies	26
Gary TL-15 Mechanical Assemblies	27
Gary TL-30 Mechanical Assemblies	28
Gary TRTL-30 (1" Mechanicsm) Mechanical Assemblies	29
Gary TRTL-30 (2" Mechanicsm) Mechanical Assemblies	30
Stickers	31
Consumables	32
Upgrade Kits	33

AUDIT VERIFICATION LOCK (AVL) PACKAGE

PART #	DESCRIPTION
AVL-002	Standard AVL Kit
T-15041000	Keypad (Outer Electronics) with Bracket
T-15042000	Primary Lock (Inner Electronics) w/ LH Swing Bolt, Standard
T-15042004	Primary Lock (Inner Electronics) w/ RH Swing Bolt, Alternate
T-15043000	Secondary Spring Lock (Knob Lock)
Y-45204	9 Vdc 500 ma Transformer
T-15044011	Armored Power/Duress Cable
T-15044001	Printer/Download Interface Cable
T-15007050	AVL Amp Connector
T-15044006	Owner's Manual



*AVL-002 Standard AVL Lock Kit
(Includes 15041000 Keypad, 15042000 Primary Lock,
and Master Key)*



T-15044011 AVL Armored Power Cable



T-15044001 AVL Printer Cable

AUDITLOK XL ELECTRONICS PACKAGE

PART #	DESCRIPTION
T-15020100	AuditLok XL Inner Board (Specify Outer Board Color)
T-15020200	AuditLok XL Outer Board, Obsolete (Green Panel)
T-15025000	AuditLok XL Outer Board (Gold Panel)
T-15020700	Communication Cable, 42" (Standard)
T-15020702	Communication Cable, 80" (JIB)
T-15021300	Peizo Alarm
T-15020900	Battery Pack, 8 Vdc
T-15000010	9V Transformers (SN <2000005061)
T-15020300	Power Mouser Cable, 26" (SN <2000005061)
T-15131600	Power Supply Connector (SN <2000005061)

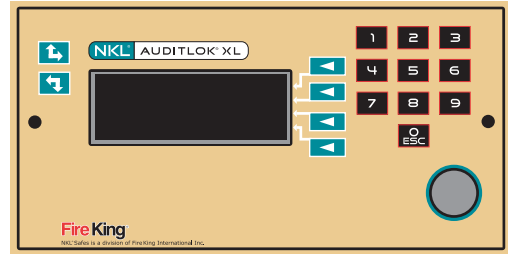

T-15025000 AuditLok XL Outer Board



T-15020200 AuditLok XL Outer Board



T-15020100 AuditLok XL Inner Board



T-15020700 Communication Cable
(Connects Outer Board to Inner Board)



T-15021300 Peizo-Electric
Speaker



T-15000010
Power Supply (9V)



T-15020300
Power Supply Cable



T-15131600
Power Supply Connector

AUDITLOK XL ELECTRONICS PACKAGE

PART #	DESCRIPTION
T-15000217	Triple Output Power Supply 5V,±12V (SN >2000005061)
T-15020310	Power Cable (SN >2000005061)
T-15020950	Battery Board (SN >2000005061)
T-15020960	Battery Jumper: Battery Board to Outer Board (SN >2000005061)
T-15020610	Alarm External Cable, 36"
T-15021100	Serial Cable: Internal Printer Harness
T-15020002	Printer Cable, RJ-DB, Optional
T-15000023	Outer Door Closure Sensor Assembly
T-15021807	Outer Door Lock Cable, 42" (Standard)
T-15021825	Outer Door Lock Cable, 48" (BSM472526)
T-15020810	Outer Door #1 Lock Cable (JIB)
T-15020811	Outer Door #3 Lock Cable (JIB)
T-15016000	Outer Door Lock, Universal Swingbolt (replaces T-15013000 or T-15012000)
T-15013000	Outer Door Lock, Swingbolt, RS/LH (Standard)
T-15012000	Outer Door Lock, Swingbolt, LS/RH (Alternate)
T-15014000	Inner Door Lock Cable (Standard)
T-15021602	Inner Door #2 Lock Cable (JIB)
T-15021603	Inner Door #4 Lock Cable (JIB)
T-15011000	Inner Door Lock, Springlock
T-15020020	AuditLok XL Owner's Manual



T-15000217 Power Supply
(Multi-Level Switch-Mode)



T-15021100 Printer Harness



T-15020002 Printer Cable

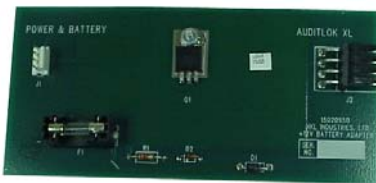

T-15020950
Power Supply Step-Down Board



T-15013000 Left Hand
Swing-Bolt Lock

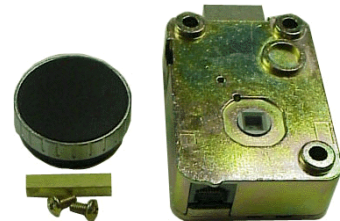

T-15011000 Knob Lock



T-15020960 Battery Adapter Cable

AUDITLOK XLV ELECTRONICS PACKAGE: D8C/D8R

PART #	DESCRIPTION
T-15059000	Outer Board (D8C)
T-15000217	Triple Output Power Supply 5V,±12V
T-1505A010	D8C Inner Electronics Assembly (Can) (T-1505B010 for Inner Door Version)
T-15058100	CPU Board
T-15056000	CPU Daughter Board
T-15054000	Lock Board
T-15052500	Cable: Power Harness
T-15020610	Cable: CPU Daughter Board J1 to Alarm
T-15009080	Cable: CPU Daughter Board J9 to Lock Board J2
T-15009053	Cable: CPU Daughter Board J6 to Display Port
T-15009080	Cable: CPU Board J4 to Program Display Port
T-15009054	Cable: CPU Board J5 to Modem Port
T-15009052	Cable: CPU Board J6 to Program Port
T-15009054	Cable: CPU Board J7 to Printer Port
T-15009053	Cable: Lock Board J1 to Vend Data Port
T-15009084	Cable: Lock Board J3 to Inner Door Lock Port
T-15054023	Cable: Lock Board J4 to Inner Door Sensor Port
T-15000191	Modular Connector (11)
T-600089	Can Case
T-700209	Can Cover
T-700139	Can Connector Plate
T-1505A012	D8R Inner Electronics Assembly (Can)
T-15052500	Cable: Power Harness
T-15000191	Modular Connector (4)
T-600089	Can Case
T-700209	Can Cover
T-700139	Can Connector Plate
T-15053000	Vend Assembly
T-1505310C	Vend Main Board
T-15053200	Vend Motor Board
T-15053300	Drop Sensor (Hinge Side)
T-15053400	Drop Sensor (Open Side)
T-15053700	Drop Sensor Cable (2)
T-15053600	Vend Ribbon Cable
T-800130	Vend Motor (4 per assembly)
T-800135	Vend Assembly Plastic Chassis
T-15052504	Armor Cable Harness Can to Vend (D8C)
T-15052502	Armor Cable Harness Can to Vend (D8R)
T-15054100	Inner Door Knob Lock (D8C)
T-15009070	Cable: Inner Lock Harness (D8C)
T-15054014	Inner Door Sensor (D8C)
T-15016000	Outer Door Lock, Universal Swingbolt
T-15054000	Lock Board (Outer Door)
T-15009084	Cable: Lock Board J3 to Outer Door Lock
T-15009080	Cable: Lock Board J1 to Vend Board
T-15054015	Outer Door Sensor (D8C)
T-15054013	Outer Door Sensor (D8R)
T-15054024	Cable: Outer Door Sensor and Armor Connection (D8R)
T-15000171	Manual Drop Drawer
T-800198	Push Button (D8R Fire Switch)
T-4720	Medeco Keyswitch (D8R Fire Switch, Optional)
T-7034	Medeco Keyswitch, Tubelock

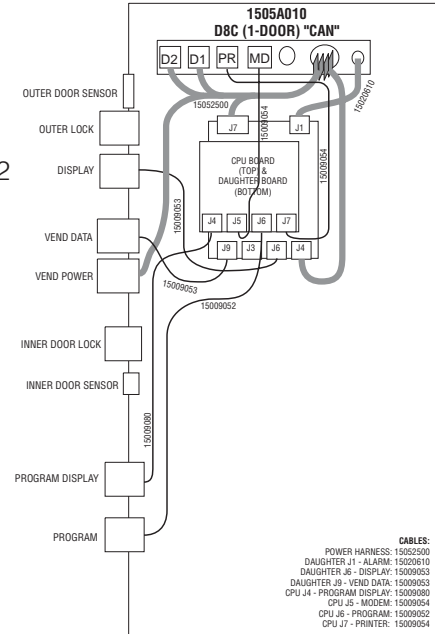

T-15059000 AuditLok XLV Outer Board

AUDITLOK XLV ELECTRONICS PACKAGE: D8X

PART #	DESCRIPTION
T-15059000	Outer Board
T-15000217	Triple Output Power Supply 5V,±12V
T-1505A011	D8X Inner Electronics Assembly (Can)
T-15052510	Cable: Power Harness
T-15000191	Modular Connector (4)
T-600089	Can Case
T-700209	Can Cover
T-700139	Can Connector Plate
T-15053000	Vend Assembly (Specify Model)
T-1505310X	Vend Main Board
T-15053200	Vend Motor Board
T-15053300	Drop Sensor (Hinge Side)
T-15053400	Drop Sensor (Open Side)
T-15053700	Drop Sensor Cable (2)
T-15053600	Vend Ribbon Cable
T-800130	Vend Motor (4 per assembly)
T-800135	Vend Assembly Plastic Chassis
T-15052505	Armor Cable Harness Can to Vend
T-15016000	Outer Door Lock, Universal Swingbolt
T-15054000	Lock Board (Outer Door)
T-15009084	Cable: Lock Board J3 to Outer Door Lock
T-15009080	Cable: Lock Board J1 to Vend Board
T-15054015	Outer Door Sensor
T-15000171	Manual Drop Drawer
T-4720	Medeco Keyswitch (ACO)
T-15097035	Medeco Keyed Alike Pair (MGR and Tubelock)
T-800316	On-Standby Keyswitch

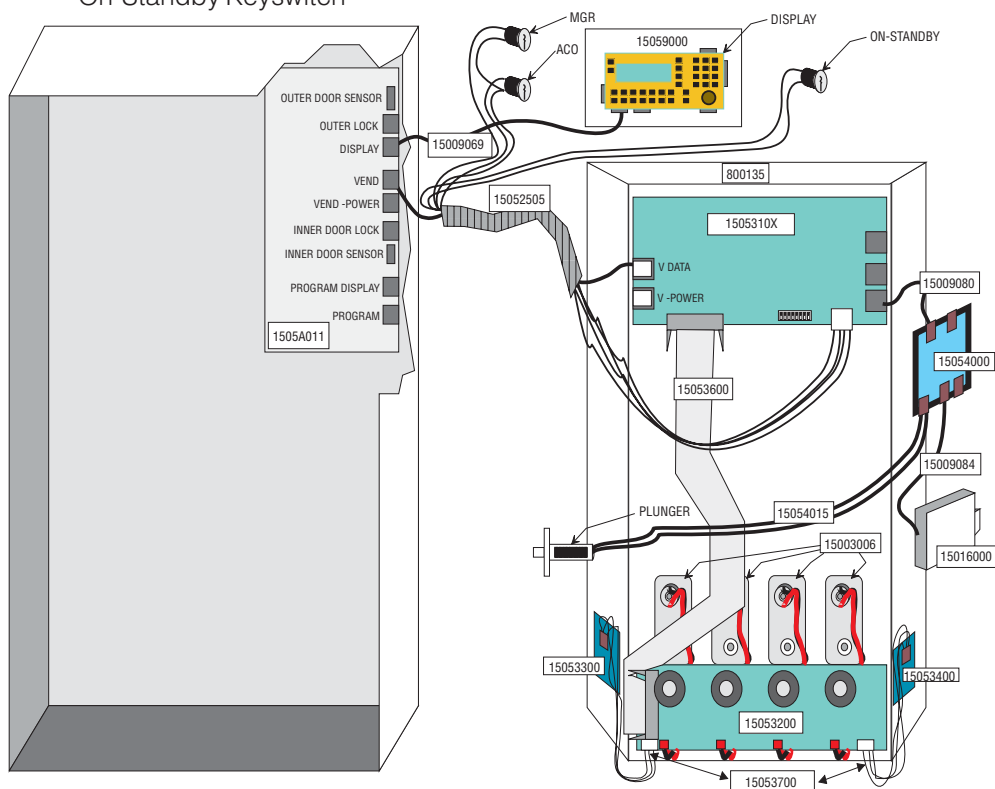

NOTE: ALL ITEMS 15053XXX ARE PART OF VEND ASSEMBLY 15053000.

D8X Electronics Assembly Diagram

AUDITLOK XLV ELECTRONICS PACKAGE: V1C

PART #	DESCRIPTION
T-1505AM15	V1C Inner Electronics, MARS Validators
T-15058100	CPU Board
T-15056000	CPU Daughter Board
T-15054000	Lock Board
T-15057000	Universal Interface Board
T-15052500	Cable: Power Harness
T-15020610	Cable: CPU Daughter Board J1 to Alarm
T-15009080	Cable: CPU Daughter Board J9 to UIB J1
T-15009053	Cable: CPU Daughter Board J6 to Display Port
T-15009080	Cable: CPU Board J4 to Program Display Port
T-15009054	Cable: CPU Board J5 to Modem Port
T-15009052	Cable: CPU Board J6 to Program Port
T-15009054	Cable: CPU Board J7 to Printer Port
T-15009052	Cable: Lock Board J1 to UIB J2
T-15009084	Cable: Lock Board J3 to Outer Door Lock Port
T-15054021	Cable: Lock Board J4 to Outer Door Sensor Port
T-15009078	Cable: Aux Power to Validator Power
T-15000191	Modular Connector (11)
T-600089	Can Case
T-700209	Can Cover
T-700139	Can Connector Plate
T-1505AJ15	V1C Inner Electronics, JCM Validators Same components as Mars version, different internal mounting

Common Components

T-15000217	Triple Output Power Supply 5V,±12V
T-15000206	Validator Power, MARS Version
T-15000326	Validator Power, JCM Version
T-15057202	Armor Cable: Can to MARS Harness
T-15057214	Armor Cable: Can to JCM Harness
T-15016000	Outer Door Lock, Universal Swingbolt
T-15052503	Armor Cable: Outer Lock Harness
T-15054013	Door Sensor

MARS Version Components

T-15072100	Mars Validator 3800, 1000 Bill
T-15072400	Mars Validator 3900, 1200 Bill
T-15072200	Mars 3800 Cassette
T-15073500	Mars 3900 Cassette, Standard
T-15073200	Mars 3900 Cassette, Locking

JCM Version Components

T-15074100	JCM Canister, WBA1000BOX
T-15074101	JCM Validator WBA1000, USA
T-15074102	JCM Validator WBA1000, UK
T-15074103	JCM Validator WBA1000, Sweeden

EPR

T-15059000	AuditLok XLV Display
T-15000223	Power Supply: 9 Vdc

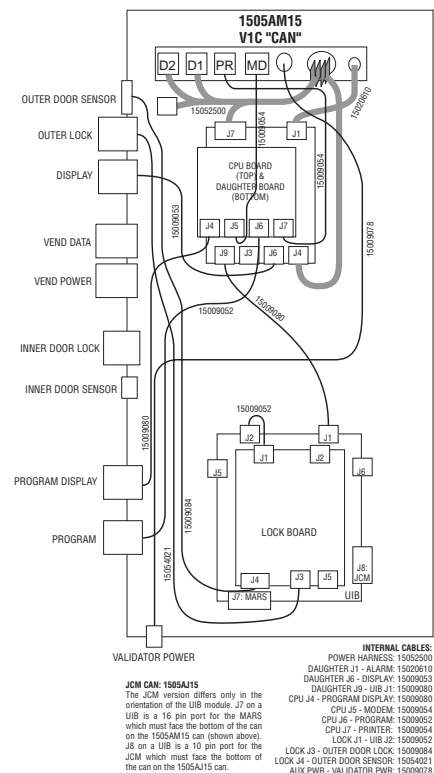

AUDITLOK XLV ELECTRONICS PACKAGE: V1R

PART #	DESCRIPTION
T-1505AM13	V1R Inner Electronics, MARS Validators
T-15054000	Lock Board
T-15057000	Universal Interface Board
T-15052500	Cable: Power Harness
T-15009052	Cable: Lock Board J1 to UIB J2
T-15009084	Cable: Lock Board J3 to Outer Door Lock Port
T-15054021	Cable: Lock Board J4 to Outer Door Sensor Port
T-15009078	Cable: Aux Power to Validator Power
T-15000191	Modular Connector (11)
T-600089	Can Case
T-700209	Can Cover
T-700139	Can Connector Plate
T-1505AJ13	V1R Inner Electronics, JCM Validators
	Same components as Mars version, different internal mounting

Common Components

T-15000217	Triple Output Power Supply 5V,±12V
T-15000206	Validator Power, MARS Version
T-15000326	Validator Power, JCM Version
T-15057202	Armor Cable: Can to MARS Harness
T-15057214	Armor Cable: Can to JCM Harness
T-15016000	Outer Door Lock, Universal Swingbolt
T-15052503	Armor Cable: Outer Lock Harness
T-15054013	Door Sensor
T-800198	Push Button (V1R Fire Switch)
T-4720	Medeco Keyswitch (V1R Keyed Fire Switch, Optional)

MARS Version Components

T-15072100	Mars Validator 3800, 1000 Bill
T-15072400	Mars Validator 3900, 1200 Bill
T-15072200	Mars 3800 Cassette
T-15073500	Mars 3900 Cassette, Standard
T-15073200	Mars 3900 Cassette, Locking

JCM Version Components

T-15074100	JCM Canister, WBA1000BOX
T-15074101	JCM Validator WBA1000, USA
T-15074102	JCM Validator WBA1000, UK
T-15074103	JCM Validator WBA1000, Sweeden

EPR

T-15059000	AuditLok XLV Display
T-15000223	Power Supply: 9 Vdc

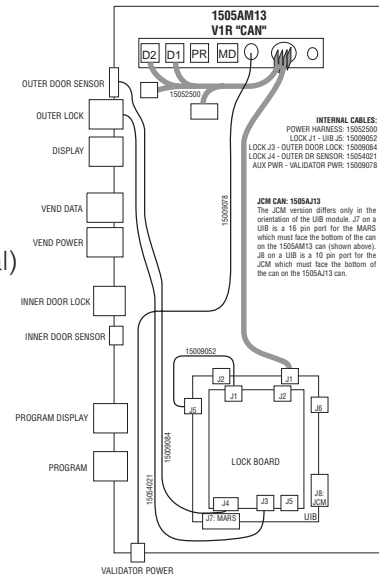

T-15072100 Mars 3800 Series Bill Validator



T-15000206 24 Vac Transformer



T-15072200 Mars Non-Locking Cassette

AUDITLOK XLV ELECTRONICS PACKAGE: V2C

PART #	DESCRIPTION
T-1505AM16	V1C Inner Electronics, MARS Validators
T-15058100	CPU Board
T-15056000	CPU Daughter Board
T-15054000	Lock Board
T-15057000	Universal Interface Board (2)
T-15052500	Cable: Power Harness
T-15020610	Cable: CPU Daughter Board J1 to Alarm
T-15009080	Cable: CPU Daughter Board J9 to UIB #2 J1
T-15009053	Cable: CPU Daughter Board J6 to Display Port
T-15009080	Cable: CPU Board J4 to Program Display Port
T-15009054	Cable: CPU Board J5 to Modem Port
T-15009052	Cable: CPU Board J6 to Program Port
T-15009054	Cable: CPU Board J7 to Printer Port
T-15009052	Cable: Lock Board J2 to UIB #1 J1
T-15009084	Cable: Lock Board J3 to Outer Door Lock Port
T-15054021	Cable: Lock Board J4 to Outer Door Sensor Port
T-15009052	Cable: UIB #1 J2 to UIB #2 J5
T-15009071	Cable: Aux Power to Validator Power
T-15000191	Modular Connector (11)
T-600089	Can Case
T-700209	Can Cover
T-700139	Can Connector Plate
T-1505AJ16	V1C Inner Electronics, JCM Validators
	Same components as Mars version, different internal mounting

Common Components

T-15000217	Triple Output Power Supply 5V,±12V
T-15000206	Validator Power, MARS Version
T-15000326	Validator Power, JCM Version
T-15057202	Armor Cable: Can to MARS Harness (2)
T-15057214	Armor Cable: Can to JCM Harness (2)
T-15016000	Outer Door Lock, Universal Swingbolt
T-15052503	Armor Cable: Outer Lock Harness
T-15054013	Door Sensor

MARS Version Components (2 Sets)

T-15072100	Mars Validator 3800, 1000 Bill
T-15072400	Mars Validator 3900, 1200 Bill
T-15072200	Mars 3800 Cassette
T-15073500	Mars 3900 Cassette, Standard
T-15073200	Mars 3900 Cassette, Locking

JCM Version Components (2 Sets)

T-15074100	JCM Canister, WBA1000BOX
T-15074101	JCM Validator WBA1000, USA
T-15074102	JCM Validator WBA1000, UK
T-15074103	JCM Validator WBA1000, Sweeden

EPR

T-15059000	AuditLok XLV Display
T-15000223	Power Supply: 9 Vdc

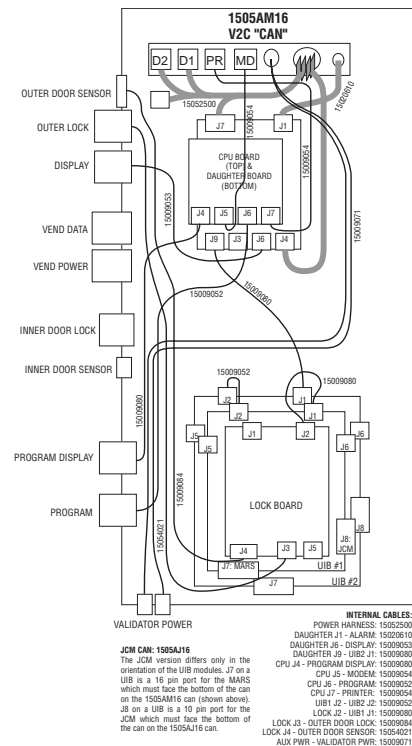

AUDITLOK XLV ELECTRONICS PACKAGE: V2R

PART #	DESCRIPTION
T-1505AM14	V1R Inner Electronics, MARS Validators
T-15054000	Lock Board
T-15057000	Universal Interface Board (2)
T-15052500	Cable: Power Harness
T-15009052	Cable: Lock Board J1 to UIB #1 J1
T-15009084	Cable: Lock Board J3 to Outer Door Lock Port
T-15054021	Cable: Lock Board J4 to Outer Door Sensor Port
T-15009052	Cable: UIB #1 J2 to UIB #2 J5
T-15009071	Cable: Aux Power to Validator Power
T-15000191	Modular Connector (11)
T-600089	Can Case
T-700209	Can Cover
T-700139	Can Connector Plate
T-1505AJ14	V1R Inner Electronics, JCM Validators
	Same components as Mars version, different internal mounting
Common Components	
T-15000217	Triple Output Power Supply 5V,±12V
T-15000206	Validator Power, MARS Version
T-15000326	Validator Power, JCM Version
T-15057202	Armor Cable: Can to MARS Harness
T-15057214	Armor Cable: Can to JCM Harness
T-15016000	Outer Door Lock, Universal Swingbolt
T-15052503	Armor Cable: Outer Lock Harness
T-15054013	Door Sensor
T-800198	Push Button (V1R Fire Switch)
T-4720	Medeco Keyswitch (V1R Keyed Fire Switch, Optional)
MARS Version Components (2 Sets)	
T-15072100	Mars Validator 3800, 1000 Bill
T-15072400	Mars Validator 3900, 1200 Bill
T-15072200	Mars 3800 Cassette
T-15073500	Mars 3900 Cassette, Standard
T-15073200	Mars 3900 Cassette, Locking
JCM Version Components (2 Sets)	
T-15074100	JCM Canister, WBA1000BOX
T-15074101	JCM Validator WBA1000, USA
T-15074102	JCM Validator WBA1000, UK
T-15074103	JCM Validator WBA1000, Sweeden
EPR	
T-15059000	AuditLok XLV Display
T-15000223	Power Supply: 9 Vdc

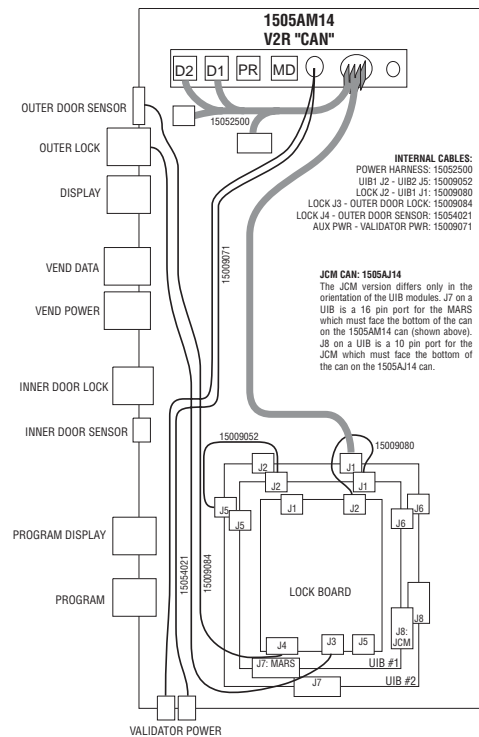

AUDITLOK XLV ELECTRONICS PACKAGE: AXC/AXR INTELLISAFE DROP SAFES

PART #	DESCRIPTION
T-15059000	Outer Board (D8C)
T-15000217	Triple Output Power Supply 5V,±12V
T-1505B017	AXC Inner Electronics Assembly (Can) for 2-Door Safes
T-15058100	CPU Board
T-15056000	CPU Daughter Board
T-15054000	Lock Board (2)
T-15052500	Cable: Power Harness
T-15020610	Cable: CPU Daughter Board J1 to Alarm
T-15009080	Cable: CPU Daughter Board J9 to Lock Board #1 J2
T-15009053	Cable: CPU Daughter Board J6 to Display Port
T-15009080	Cable: CPU Board J4 to Program Display Port
T-15009054	Cable: CPU Board J5 to Modem Port
T-15009052	Cable: CPU Board J6 to Program Port
T-15009054	Cable: CPU Board J7 to Printer Port
T-15009053	Cable: Lock Board #1 J1 to Lock Board #2 J1
T-15009084	Cable: Lock Board #1 J3 to Inner Door Lock Port
T-15054023	Cable: Lock Board #1 J4 to Inner Door Sensor Port
T-15009084	Cable: Lock Board #2 J3 to Outer Door Lock Port
T-15054021	Cable: Lock Board #2 J4 to Outer Door Sensor Port
T-15000191	Modular Connector (11)
T-600089	Can Case
T-700209	Can Cover
T-700139	Can Connector Plate
T-1505A017	Single Door Version of AXC Can
T-1505A0ZZ	AXR Inner Electronics Assembly (Can) for 2-Door Safes
T-15054000	Lock Board (2)
T-15052500	Cable: Power Harness
T-15009053	Cable: Lock Board #1 J1 to Lock Board #2 J1
T-15009084	Cable: Lock Board #1 J3 to Inner Door Lock Port
T-15054023	Cable: Lock Board #1 J4 to Inner Door Sensor Port
T-15009084	Cable: Lock Board #2 J3 to Outer Door Lock Port
T-15054021	Cable: Lock Board #2 J4 to Outer Door Sensor Port
T-15000191	Modular Connector (11)
T-600089	Can Case
T-700209	Can Cover
T-700139	Can Connector Plate
T-1505A0NZ	Single Door Version of AXR Can
T-15016000	Outer Door Lock
T-15054013	Outer Door Sensor
T-15052503	Armor Cable: Can to Outer Door Lock
T-15011000	Inner Door Lock
T-15054014	Inner Door Sensor
T-15009070	Armor Cable: Can to Inner Door Lock
T-800198	Push Button (AXR Fire Switch)
T-4720	Medeco Keyswitch (AXR Fire Switch, Optional)

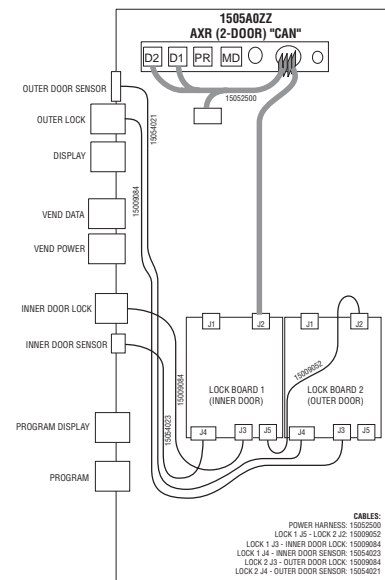
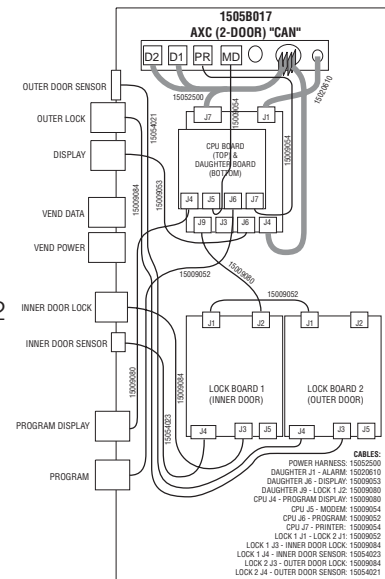

AUTOBANK "27 SERIES"

PART #	DESCRIPTION
T-15094528	Display Board
T-15094529	Main Logic Board
T-4530	Main Board to Display Board Communication Cable
T-4050-02	Keypad Membrane
T-15099542	Swingbolt Lock
T-1036	Power Supply Cable Harness, Includes Power Switch and Fuse Holder
T-1018	Key/Lock Cable Assembly
T-4693	Autobank 27 Series Transformer 12 Vac
T-15097035	Medeco Keyswitch Pair, Door/Tubelock Keyed Alike with 2 Keys
T-4720	Medeco Keyswitch, ACO with 2 Keys
T-10481	Keyswitch, On-Stby with 2 Keys
T-1042	Tube Lock Cam
T-7255	Tube Blocking Bar
T-1130	Chute - New Style
T-1122	Interruptor Strip
T-72000001	Plunger Motor
T-72000002	Sled Motor
T-3921-02	Drive Unit Cable
T-3918	Sled/Tray Assembly
T-15094521	Sensor Board
T-9788	Deposit Drawer



T-4050-02 Keypad Membrane



T-9788 Manual Drop Drawer



T-15099542 Lock



T-15094528 Display Board

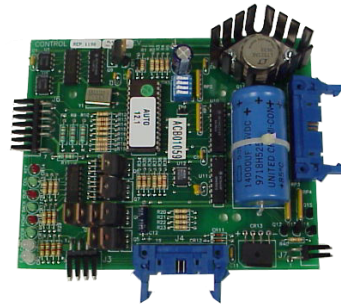

T-15094529 Main Logic Board



T-4530 Main-Display Cable

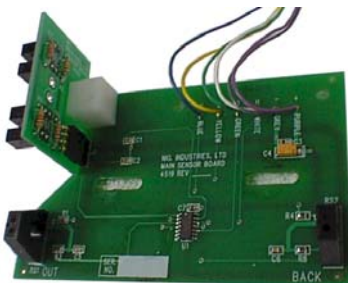

T-15094521 Sensor Board



T-72000001/T72000002 Pittman Sled/Plunger Motor

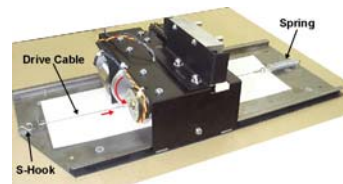

T-3918 Sled Assembly

AUDITOR SERIES AUTOBANK: COMMON ELECTRONICS

PART #	DESCRIPTION
T-15099550	CPU Board: specify model to ensure correct software revision
T-15099551	Driver Board
T-15099552	Display Board
T-15099553	Lock Controller Board, AB283V/2000/FS
T-15097414	Power Supply Board (Current)
T-4620	12V Regulator 2N2683
T-4681	Q1 Socket
T-1054	5V Regulator LT-323 AK5
T-4680	VR2 Socket
T-4626	T03 Insulator, Mica
T-15000319	Autobank Auditor Keypad Membrane, AB28/2000
T-15140500	Autobank Auditor Keypad Switch Membrane, DeposiTTrac/FS
T-18000001	Remote Display Panel Assembly, DeposiTTrac



T-15099550 CPU Board



T-15000319 Auditor Keypad Switch Membrane

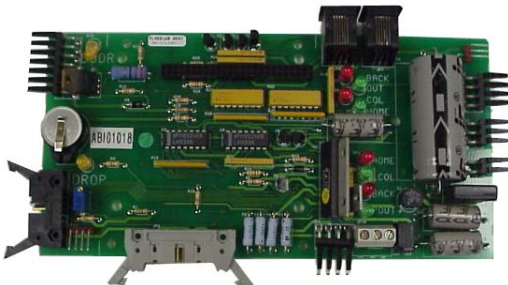

T-15099551 Driver Board



T-15099552 Display Board



T-15097414 Power Supply Board



T-15099553 Lock Controller Board



T-4680/T-4681
Transistor/Regulator Sockets



T-4620 and T-1054
Transistor/Regulator Devices

AUDITOR SERIES AUTOBANK: VENDING, PRINTING, VALIDATING

PART #	DESCRIPTION
T-4699	Sled/Tray Assembly
T-72000001	Plunger Motor (part of T-4699)
T-72000002	Sled Motor (part of T-4699)
T-3921-02	Drive Unit Cable (part of T-4699)
T-15099995	Serial Printer
T-9988	Adapter DR25 to RJ45 for Printer
T-1209	Printer Cable 20', RJ45
T-15105090	FS Series Printer Cable
T-4637	Onboard Printer (Older AB2000 Units)

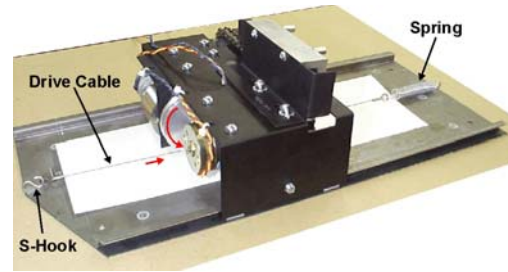

T-4699 Sled/Tray Assembly



T-72000001/T72000002
Pittman Sled/Plunger Motor



T-9988 Printer RJ45/
DB25 Adapter



T-15099995 OM100 Serial
Receipt Printer

T-15072100	Mars Validator 3800, Non-Locking (was T-7322)
T-15072400	Mars Validator 3900, Locking (was T-7322LK)
T-15072200	Mars 3800 Bill Cassette, Non-Locking (was T-7323)
T-15073200	Mars 3900 Bill Cassette, Locking (was T-7323LK)
T-15072300	Mars RS485 Interface Module (was T-7324)
T-1187	Mars 24 Vac Transformer (Single Validator, obs. 8-99)
T-15000206	Mars Validator 24 Vac 90 VA Transformer
T-15105199	Mars Validator Harness, AB283V (use with 15000206 transformer)
T-15105197	Mars Validator Harness, AB2000 (use with 15000206 transformer)
T-15105198	Mars Validator Harness, AB2000T (use with 15000206 transformer)
T-15105010	Mars Validator Harness, FS Series (use with 15000206 transformer)
T-15091031	Rowe Link Harness
T-15071000	Rowe Validator RGA-7 (was T-9509)
T-8000	Rowe Validator Box
T-15071001	Rowe Cassette #65404000 (T-9510)
T-15071002	Rowe Validator RBA-7 (T-9955)
T-15071003	Rowe Cassette (T-9957)
T-9996	Rowe Cleaning Kit ROWE
T-4601	Power Supply Board (Instead of T-15097414 on Units With Rowe Validators)
T-7068	Locks for Lockable Cassette



T-15072100 Mars 3800
Series Bill Validator



T-15072200 Mars Non-
Locking Cassette



T-15072300 RS485
Interface Module for Mars
Validators



T-15000206 24 Vac
Transformer

SHERLOCK ELECTRONIC LOCK PACKAGE

PART #	DESCRIPTION
Y-46000	SherLock Outer Board
Y-46001	SherLock Inner Board
Y-46002	SherLock Communication Cable (outer to inner board)
Y-ADAPTER	Adapter for Outer Board
Y-45204	Transformer, 9 Vdc
T-15016000	Lock, Universal Swingbolt (replaces T-15013000 or T-15012000)
T-15012000	Lock, Swingbolt, LH/RS (standard)
T-15013000	Lock, Swingbolt, RH/LS (alternate)
T-15011000	Lock, Springbolt, Inner Door
T-15014000	Inner Door Lock Cable

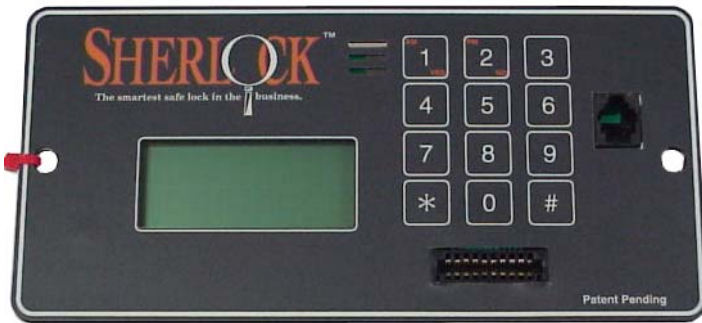

Y-46000 Sherlock Outer Board

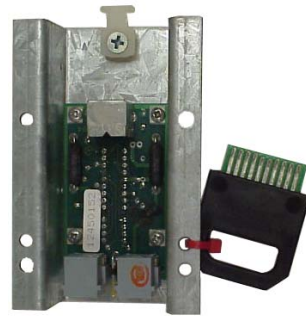

Y-46001 Sherlock Inner Board

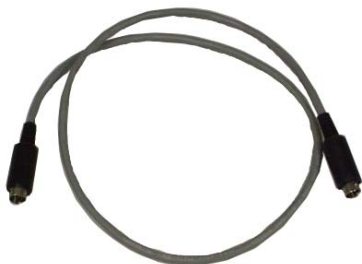

Y-46002 Sherlock Communication Cable



Y-45204 Power Supply



T-15031350 Mouser:
FK Power Supply Mouser?



T-15013000 Left Hand
Swing-Bolt Lock



T-15011000 Knob Lock

TIMELOK XL ELECTRONIC LOCK PACKAGES

PART #	DESCRIPTION
T-15131100	TimeLok XL Inner Board V2.0 (was Y-45154)
T-15131200	TimeLok XL Outer Board V2.0 (was Y-45155)
T-15020700	Communication Cable (inner to outer board, was Y-45151)
Y-45204	Transformer, 9 Vdc (requires 15131360 mouser cable)
T-15131360	Power Supply Mouser Cable (use with Y-45204 transformer)
T-15000010	Transformer, 9 Vdc (replaces Y45204 since early 2000)
T-15016000	Lock, Universal Swingbolt (replaces T-15013000 or T-15012000)
T-15012000	Lock, Swingbolt, LH/RS (standard)
T-15013000	Lock, Swingbolt, RH/LS
T-15011000	Lock, Springbolt, Inner Door
T-15014000	Inner Door Lock Cable
T-15014002	Outer Door Lock Cable, 42" Standard



T-15131200 TimeLok XL Outer Board



T-15131100 TimeLok XL Inner Board



*T-15020700 Communication Cable
(Connects Outer Board to Inner Board)*



*T-15031350 Mouser:
FK Power Supply Mouser?*



*Y-45175 Gama TimeLok
Display*



Y-45204 Power Supply

VINDICATOR 1 (AUDITLOK) ELECTRONIC LOCK PACKAGES

PART #	DESCRIPTION
T-15121000	Outer Board
Y-45116	Communcation Cable
T-15122000	Inner Board
T-1510517	Owner's Manual
Y-45204	Transformer, 9 Vdc
Y-16000	Power Supply Mouser Cable (for Y-45204)
T-15084006	Printer Cable, 72"
T-15016000	Outer Door Lock, Universal Swingbolt (replaces T-15013000 or T-15012000)
T-15012000	Lock, Swingbolt, LH/RS (standard)
T-15013000	Lock, Swingbolt, RH/LS (alternate)
T-15011000	Lock, Springbolt, Inner Door
T-15014000	Inner Door Lock Cable
T-15014002	Outer Door Lock Cable, 42" Standard
T-15003007	Magnetic Door Contact Sensor



T-15121000 Outer Board



T-15122000 Inner Board



T-15013000 Left Hand
Swing-Bolt Lock



Y-45204 9 Vdc Power Supply



T-15011000 Knob Lock



T-15003007 Magnetic
Door Contact

VINDICATOR 2 ELECTRONIC LOCK PACKAGES

PART #	DESCRIPTION
T-15082000	Vindicator 2 Outer Board
T-15081000	Vindicator 2 Inner Board
T-15083500	Vindicator 2 Communication Cable
T-15083000	Transformer, 16 Vac (Vindicator 2, was T-9576)
T-15084000	Transformer Cable (for T-9576)
T-15084006	Printer Cable, 72"
T-15099541	Lock, Swingbolt, LH/RS (standard)
T-15099542	Lock, Swingbolt, RH/LS (alternate)
T-9390	Outer Door Lock Cable, 42" Standard
T-9349	Lock, Springbolt, Inner Door
T-9391	Inner Door Lock Cable
T-15003007	Magnetic Door Contact Sensor



T-15082000 Outer Board



T-15083000 16.5 Vac Transformer



T-15081000 Inner Board



T-15084000 Transformer Cable

DIGITAL KEYPADS

PART #	DESCRIPTION
T-6101058	Lagard 3802 Keypad/Lock Kit
T-6101058K	Lagard 3802 Keypad Only
T-6101058L	Lagard 3802 Lock Only
T-15134100	Lagard 3600 Keypad Lock (was Y-45120) (3600 is an upgrade from 3802)
T-15134110	Lagard 3600 Keypad (was Y-45118)
T-15134120	Lagard 3600 ComboGard Keypad, works with T-1534100 Lock (was Y-45135)
T-15134600	Lock for ComboGard w/Small Battery & Alarm Box (was T-9556)
T-7040	S&G 6120 Keypad with Lock
T-7040-1	S&G 6120 Keypad Only
T-7040-2	S&G 6120 Lock Only



*T-15134120 LaGard
ComboGard Keypad*



T-15134110 LaGard Keypad



T-7040-1 S&G 6120 Keypad



T-15134600 33E Lock



T-15134500 Time Delay Lock

DIAL & KEY LOCKING COMPONENTS

PART #	DESCRIPTION
T-15045036	S & G Key Op Lock Only (was Y-45036)
T-20056-018	E-ring, Truarc (5133-31)
T-3264	Dial Bushing
T-3265	Dial Insert Non-Key Lk
T-3265-1	Dial Insert Key Lock
T-3408	Lagard LK 3300 Combo
T-3410	Lagard 3330 Group 2
T-3415	1777 Flat Guard
T-3416	1779 Flat Gard Dial & Ring (Keylocking)
T-3515	LK S&G Group II Combo
T-3600	LK S&G 8550-002
T-3602	LK S&G 4113-001 1/2"
T-3610	8560 Combo
T-3623	LK S&G 6804-003
T-3671	SSB 6510 Lockbox
T-3822	Key Cylinder D225
T-3889	Dial Ring S&G R132-01
T-3890	Dial Ext. Kit S&G 7312
T-4132	Dial S&G D220-039 SAT
T-4133	Dial Conv. Spy Proof Dial
T-4394	Dial Ring S&G R131-12
T-7045	S&G 6210-007 Knob Lock
T-7051	S&G Ring R67-013
T-7054	Dial S&G D221-004
T-7306	Medico Cam Lock
T-9202	Best Lock 5L7RL2-626 w/core
T-9204	Lock Best 5L7RL4 w/o Core 626
T-9205	Best Cabinet Lock
T-9207	Lock Best 626 Rim Cly
T-9211	CORE KEY FOR BEST LOCK
T-9212	BEST CORE WITH 2 KEYS
T-9249	Lock, Ilco PH40 Lever
T-9512-2	Dial Insert 1753
T-9936	Medecop Core w/2 Keys
T-9937	Wedge Locks (Case Only)
Y-45002	4440 LH Lock
Y-45020	Dial D300
Y-45026	Dial Ring
Y-45027	Lagard Lock
Y-45028	Largard Dial & Ring
Y-45043	99 E Key Cylinder



T-3602 Single
Nose Lock

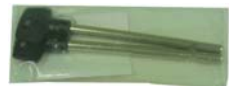

T-3439LK LaGard Lock
(T-3442-32 Keys
Included)



Y-45003 Dual
Keylock 4440



Y-45043 Key
Cylinder



T-15045138
Lock &
T-15045039
Keys



T-7051 S&G
Dial Ring



Y-45020 Dial
D300



Y-45028 LaGard Dial Ring

NKL "3-SERIES" (MEILINK CASHVAULT) MECHANICAL ASSEMBLIES

PART #	DESCRIPTION
T-10209001	Complete Door With Slot (includes all boltwork, hinges, handle...)
T-10209002	Complete Door Without Slot (includes all boltwork, hinges, handle...)
T-10200013	Detent Block Detent Assembly
T-06041004	Bushing, Nylon (qty 2)
T-06500003	Torsion Spring (1/2 x 7/16 x .038)
T-10200012	Detent Arm, 3-point
T-06141004	Clevis Pin
T-06151002	Cotter Pin
	Boltworks Assembly
T-10200037	LaGard 3-Point Boltwork Mechanism
T-06141004	Screws, 10-32 x 3/8
	Bolt Assembly
T-10200022	Vertical Bolt (qty 2)
T-10200021	Horizontal Bolt
T-06020004	Flat Washer 3/8 ID x 1
T-06500002	Expansion Spring 0.5 x 3.5 x .05 (qty 2)
T-06151001	Cotter Pin (qty 3)
T-06141001	Clevis Pin (qty 3)
	Door Closure Assembly
T-06500007	Door Closure Spring
T-10300010	Door Closure Tube
T-08001003	Door Closure Tip (plastic)
T-10200029	Hinge Assembly (qty 2)
T-10200023	Hinge Leaf
T-10200039	Hinge Pin
T-10200038	Hinge Knuckle
T-06010004	Screw, 5/16 x 18 x 3/4 (4 per hinge)
T-06010006	Screw, 1/4 x 20 x 3/8
T-06061003	Screw, 1/4 x 20 x 1/4
	Handle Assembly
T-10000155	T-Handle, 3-Series
T-06091007	Hex Jam Nut, Self Locking, 5/16-18



Detent Assembly Parts



10200037 LaGard 3-Point Boltwork Mechanism



T-10200029 Hinge Assembly



10000155 T Handle (Y-35057)

NKL PREMIUM SERIES (INTELLISAFE) MECHANICAL ASSEMBLIES

PART #	DESCRIPTION
T-10039003	BSM292020 Complete RS Door (includes all boltwork, hinges, handle...)
T-10029002	BSM322020 Complete RS Door (includes all boltwork, hinges, handle...)
T-10019003	BSM412626 Complete RS Door (includes all boltwork, hinges, handle...)
T-10089003	BSM472526 Complete RS Door (includes all boltwork, hinges, handle...)
T-10019003L	BSM412626 Complete LS Door (includes all boltwork, hinges, handle...)
T-10089003L	BSM472526 Complete LS Door (includes all boltwork, hinges, handle...)

Dust Covers

T-10030026	292020 RS Dust Cover
T-10030026L	292020 LS Dust Cover
T-10020026	322020 RS Dust Cover
T-10020026L	322020 LS Dust Cover
T-10010043	412626 RS Dust Cover
T-10010043L	412626 LS Dust Cover
T-10080009	472526 RS Dust Cover
T-10080009L	472526 LS Dust Cover
T-06020006	Washer (qty 4, each cover)
T-06035001	Torx Bit (qty 4, each cover)

T-600079	Handle Assembly (Before June 2000)
T-10000058	L-Handle
T-06500004	Handle Spring
T-06041007	Handle Bushing, Nylon
T-06141002	Clevis Pin for Handle Link
T-10000003	Handle Linkage
T-06091006	Hex Jam Nut, 5/8 Self Locking



T-10000058 Premium Series Handle

T-600080	Boltworks Cam Assembly
T-10000001	Y-Cam for 5-Point Boltwork
T-06020008	Cam Washer, Inner
T-06020001	Cam Washer, Outer
T-06500002	Cam Spring (qty 2)
T-06141001	Clevis Pin, Bolt Linkage (qty 6)



T-10000003 Handle Cam Linkage

T-600081	Boltworks E-Bar Assembly
T-10000133	E-Bar Assembly RS
T-10000134	E-Bar Assembly LS
T-06041006	Bushing, Brush (qty 6)
T-06151001	Cotter Pin (qty 13)

Boltworks Vertical Bar Components

T-10030141	292020 Vertical Bolt (qty 2)
T-10020141	322020 Vertical Bolt (qty 2)
T-10010141	412626 Vertical Bolt (qty 2)
T-10080141	472526 Vertical Bolt (qty 2)



T-06500002 Cam Spring



E-Bolt and Cam Boltwork Hardware

NKL PREMIUM SERIES (INTELLISAFE) MECHANICAL ASSEMBLIES

PART # DESCRIPTION

T-600082	Detent Assembly
T-06041004	Bushing, Nylon (qty 2)
T-06500003	Torsion Spring (1/2 x 7/16 x .038)
T-10000004	Detent Arm, 5-Point
T-06151002	Cotter Pin
T-10000006	Detent Stop
T-06141004	Screw, 10-32 x 3/8
T-600083	Relocker Assembly
T-10000138	Relocker Pin
T-06500006	Relocker Spring
T-10000002	Relocker Bracket (RS)
T-10000021	Relocker Bracket (LS)
T-06030007	Relocker Screws, 8-32 x 1/2
T-600085	Door Closure Assembly
T-06500005	Door Closure Spring
T-10000052	Door Closure Tube
T-08001003	Door Closure Tip (plastic)
T-600086	Door Switch Assembly
T-10000089	Door Switch Bracket
T-06030011	Screw, Pan Machine 6-32 (qty 2)
T-06010006	Screw, 1/4 x 20 x 3/8
T-15000023	Door Switch
T-06131002	Keps Nuts 6-32
T-600084	Hinge Assembly (qty 2)
T-10000151	Hinge Shim
T-10000027	Hinge Knuckle (RS)
T-10000027L	Hinge Knuckle (LS)
T-06071006	Hinge Pin Dowel
T-06010001	Screw, 5/16 x 18 x 1 1/4 (qty 4 per hinge)
T-06061006	Set Screw, 5/16 x 18 x 3/4
T-06061005	Set Screw, 3/8 x 16 x 1/4 (qty 2 per hinge)



T-10000004 Detent Arm



T-06500005 Door Closure Spring



T-10000052 Door Closure Tube



T-15000023 Door Closure Sensor Switch & T-10000089 Bracket



T-10000027/T-10000027L Hinges

NKL D8 AUTOBANK MECHANICAL ASSEMBLIES

PART # DESCRIPTION

DETENT COMPONENTS:

T-800186	Detent Spring
T-700028	Detent Bracket
T-600048	Detent Rod Assembly, D8
T-700032	Detent Rod, D8
T-800211	Adjustment Sleeve Stand-Off
HN700	Adjustment Hex Locking Nut, 8-32



T-700028 Detent Bracket

BOLTWORK COMPONENTS:

T-800153	"T" Handle
T-700007	Latch Bolt (3)
T-600025	Latch Bolt Cam (3)
T-600027	Side Actuator Plate (2)
T-600028	Reverse (bottom) Actuator Plate
T-600029	Handle Actuator Plate
T-800218	Main Spring
T-700041	Actuator Link Plate (Connecting Bar)
T-800112	Shoulder Bolt 5/16 x 3/8 (3)
T-800129	Retaining Clip, Type E, 3/16
T-800152	External Retaining 7/16
T-800175	Washer, #8, 7/16 OD (3)
T-800182	Screw, #10-32 Button Head Cap 5/16 (7)
T-800184	Wave Washer, 7/16



T-700007 Latch Bolt



T-600027 Side Actuator Plate

HINGE COMPONENTS:

T-600030	Door Hinge Assembly, 1 x 3 1/2 (2)
T-700039T	Hinge Body Top
T-700039B	Hinge Body Bottom
T-800149	Hinge Pin
T-800151	Ball Bearing
T-800176	Set Screw 1/2 x 20 x 1/2
T-800150	Brass Bushing



T-600113 Tubelock Actuator Cam

MISCELLANEOUS:

T-600064	Drawer, 3 x 4.5 x 8
T-16000002	Tube Lock Plate
T-600113	Tube Lock Actuator Cam
T-7034	Tube Lock Key Switch
T-800254	D8 Dust Cover
T-06030008	Screw, #4-40 Phillips 1/4 (7) for Cover
T-800328	Screw, 5/16 - 18 Thread Socket Head 7/8 (4) for Vend Assembly Mounting
T-800339	Operator's Manual (D8C/D8R)
T-800338	Operator's Manual (D8X)
T-800346	Installation Instructions
T-800208	D8 Label 1/2 x 3 7/8
T-800268	Autobank Label 3.5 x 14.25
T-800301	Label (Rear) 1 5/8 x 7 1/4
T-800372	Anchor Kit



T-800328 Vend Mounting Shoulder Bolt

NKL V1 AUTOBANK MECHANICAL ASSEMBLIES

PART # DESCRIPTION

DETENT COMPONENTS:

T-800186	Detent Spring
T-700028	Detent Bracket
T-600047	Detent Rod Assembly, V1
T-700027	Detent Rod, V1
T-800211	Adjustment Sleeve Stand-Off
HN700	Adjustment Hex Locking Nut, 8-32



T-600047 Detent Rod Assembly, V1

BOLTWORK COMPONENTS:

T-800153	"T" Handle
T-700007	Latch Bolt (3)
T-600025	Latch Bolt Cam, 1/4 Insert (2)
T-600024	Latch Bolt Cam, 1/2 Insert (1)
T-700009	Actuator Plate
T-600027	Side Actuator Plate
T-600028	Reverse Actuator Plate
T-600029	Handle Actuator Plate
T-800218	Main Spring
T-700012	Actuator Link Plate (Connecting Bar)
T-800112	Shoulder Bolt 5/16 x 3/8 (3)
T-800129	Retaining Clip, Type E, 3/16
T-800152	External Retaining 7/16
T-800175	Washer, #8, 7/16 OD (3)
T-800182	Screw, #10-32 Button Head Cap 5/16 (8)
T-800184	Wave Washer, 7/16



T-700009 Actuator Plate



T-600028 Reverse Actuator Plate



T-600029 Handle Actuator Plate

HINGE COMPONENTS:

T-600011	V1 Door Hinge Assembly, 7/8 x 2 1/2 (2)
T-700014T	Hinge Body Top
T-700014B	Hinge Body Bottom
T-800092	Hinge Pin
T-800093	Ball Bearing
T-800094	Set Screw 1/2 x 20 x 1/2
T-800095	Brass Bushing



T-800218 Main Spring

VALIDATOR FITTINGS:

T-600015	Mounting Plate (MARS)
T-600038	Left Mounting Plate (JCM)
T-600039	Right Mounting Plate (JCM)
T-800174	Hex Nut, #10-24, Validator Mounting (4, MARS)
T-800128	Screw, M4 x 6, Validator Mounting (6, JCM)
T-800110	Nylon Flange Bushing (2)
T-800146	Nylon Flange Washer (2)
T-800313	Shoulder Bolt, 1/2 x 3/8 with 3/4 Hex Head (2)

MISCELLANEOUS:

T-800339	Operator's Manual
T-800346	Installation Instructions
T-800209	V1 Label 1/2 x 3 7/8
T-800269	Autobank Label 3.5 x 8.5
T-800301	Label (Rear) 1 5/8 x 7 1/4
T-800312	Validator Bezel Gasket
T-700218	Validator Bezel Gasket Retainer
T-700219	Door Cover, V1
T-800372	Anchor Kit

NKL V2 AUTOBANK MECHANICAL ASSEMBLIES

PART # DESCRIPTION

DETENT COMPONENTS:

T-800186	Detent Spring
T-700028	Detent Bracket
T-600071	Detent Rod Assembly, V2
T-700103	Detent Rod, V2
T-800211	Adjustment Sleeve Stand-Off
HN700	Adjustment Hex Locking Nut, 8-32

BOLTWORK COMPONENTS:

T-800153	"T" Handle
T-700007	Latch Bolt (3)
T-600025	Latch Bolt Cam, 1/4 Insert (2)
T-600024	Latch Bolt Cam, 1/2 Insert (1)
T-700009	Actuator Plate
T-600027	Side Actuator Plate
T-600028	Reverse Actuator Plate
T-600029	Handle Actuator Plate
T-800218	Main Spring
T-700012	Actuator Link Plate (Connecting Bar)
T-800112	Shoulder Bolt 5/16 x 3/8 (3)
T-800129	Retaining Clip, Type E, 3/16
T-800152	External Retaining 7/16
T-800175	Washer, #8, 7/16 OD (3)
T-800182	Screw, #10-32 Button Head Cap 5/16 (10)
T-800184	Wave Washer, 7/16



T-700012 Actuator Link Plate



T-600024 Bolt Cam
1/2" Insert



T-600025 Bolt Cam
1/4" Insert

HINGE COMPONENTS:

T-600030	V2 Door Hinge Assembly, 1 x 3 1/2 (2)
T-700039T	Hinge Body Top
T-700039B	Hinge Body Bottom
T-800149	Hinge Pin
T-800151	Ball Bearing
T-800176	Set Screw 1/2 x 20 x 1/2
T-800150	Brass Bushing

VALIDATOR FITTINGS (2 SETS):

T-600015	Mounting Plate (MARS)
T-600038	Left Mounting Plate (JCM)
T-600039	Right Mounting Plate (JCM)
T-800174	Hex Nut, #10-24, Validator Mounting (4, MARS)
T-800128	Screw, M4 x 6, Validator Mounting (6, JCM)
T-800110	Nylon Flange Bushing (2)
T-800146	Nylon Flange Washer (2)
T-800313	Shoulder Bolt, 1/2 x 3/8 with 3/4 Hex Head (2)



T-600015 MARS Validator
Cover Plate

MISCELLANEOUS:

T-800339	Operator's Manual
T-800346	Installation Instructions
T-800207	V2 Label 1/2 x 3 7/8
T-800269	Autobank Label 3.5 x 8.5
T-800301	Label (Rear) 1 5/8 x 7 1/4
T-800312	Validator Bezel Gasket (2)
T-700218	Validator Bezel Gasket Retainer (2)
T-700226	Door Cover, V2
T-800372	Anchor Kit

GARY TL-15 MECHANICAL ASSEMBLIES

PART #	DESCRIPTION
	Handle Assembly
T-10000199	Handle Spindle
T-3114	Handle (1" Door)
T-3780	Yoke, LS
T-3781	Yoke, RS
	Hinge Assembly
T-3531	Hinge Body Top
T-3532	Hinge Body Bottom
T-3554	Hinge Pin
T-3207	Ball Bearing (qty 2)
T-6166	Screw (qty 2)
T-6240	Screw (qty 4)
HS1307	Screw (qty 2)
	Detent Assembly
T-3269	Detent
T-3688	Detent Spring
	Relocker Assembly
T-3593	Relocker Pin
T-*	Relocker Spring
T-*	Relocker Holder
	Boltwork Assembly
T-*	Center Bolt
T-*	Outer Bolt (2 per assembly)
T-*	Carriage Bar Bracket
T-*	Carriage Bar, 14"
T-*	Carriage Bar, 28"
T-*	Carriage Bar, 38"
<i>*Call for part number</i>	

GARY TL-30 MECHANICAL ASSEMBLIES

PART #	DESCRIPTION
	Handle Assembly
T-2031	Handle Spindle
T-3113	Handle
T-3780	Yoke, LS
T-3781	Yoke, RS
	Hinge Assembly
T-3531	Hinge Body Top
T-3532	Hinge Body Bottom
T-3554	Hinge Pin
T-3207	Ball Bearing (qty 2)
T-6166	Screw (qty 2)
T-6240	Screw (qty 4)
HS1307	Screw (qty 2)
	Detent Assembly
T-3269	Detent
T-3688	Detent Spring
	Relocker Assembly
T-3593	Relocker Pin
T-*	Relocker Spring
T-*	Relocker Holder
	Boltwork Assembly
T-9009	Center Bolt
T-3273	Outer Bolt (2 per assembly)
T-3300	Carriage Bar Bracket
T-3195	Carriage Bar, 14"
T-3197	Carriage Bar, 28"
T-3199	Carriage Bar, 38"

*Call for part number



T-3113 L Handle

GARY TRTL-30 (1" MECHANISM) MECHANICAL ASSEMBLIES

PART #	DESCRIPTION
	Handle Assembly
T-9970	Handle Spindle
T-9275	Handle
T-3780	Yoke, LS
T-3781	Yoke, RS
	Hinge Assembly
T-3533	Hinge Body Top
T-3534	Hinge Body Bottom
T-3555	Hinge Pin
T-3208	Ball Bearing
	Hinge Cover: Cut Per Order
	Detent Assembly
T-3851	Detent
T-3688	Detent Spring
	Relocker Assembly
T-9003	Relocker Pin
T-9004	Relocker Spring
T-9131	Relocker Holder
	Boltwork Assembly
T-9015	Center Bolt
T-3795	Outer Bolt (2 per assembly)
T-3300	Carriage Bar Bracket
T-3195	Carriage Bar, 14"
T-3197	Carriage Bar, 28"
T-3198	Carriage Bar, 38"

GARY TRTL-30 (2" MECHANISM) MECHANICAL ASSEMBLIES

PART #	DESCRIPTION
	Handle Assembly
T-9972	Handle Spindle
T-9275	Handle
T-3780	Yoke, LS
T-3781	Yoke, RS
	Hinge Assembly
T-3533	Hinge Body Top
T-3534	Hinge Body Bottom
T-3555	Hinge Pin
T-3208	Ball Bearing
	Hinge Cover: Cut Per Order
	Detent Assembly
T-9108	Detent
T-3688	Detent Spring
	Relocker Assembly
T-9003	Relocker Pin
T-9004	Relocker Spring
T-9131	Relocker Holder
	Boltwork Assembly
T-9066	Center Bolt
T-9065	Outer Bolt (2 per assembly)
T-3856	Carriage Bar Bracket
T-9070	Top/Bottom Bolt (qty 2, 5 Bolt Mechanism Only)
T-9123	Pivot Cam (qty 2, 5 Bolt Mechanism Only)
T-9086-1	Linkage Arm (qty 2, 5 Bolt Mechanism Only)
T-9086-2	Linkage Arm (qty 2, 5 Bolt Mechanism Only)

STICKERS

PART #	DESCRIPTION
T-3393	Warning Label
T-3673	Label, Denomination
T-3815	Label, Time Lock
T-4288	Warning Label
T-45187	Warning Label for Mot
T-45190	Label for Tech Suppor
T-45405	Sticker for Taco Bell
T-4623	Warning Sticker
T-7291	Label Hinge Tab
T-800207	V2 Autobank
T-800208	D8 Autobank
T-800209	V1 Autobank
T-800268	Autobank 3.5 x 14.25
T-800269	Autobank 3.5 x 8.5
T-800301	XLV Rear Panel Connector Label
T-9000	Label Package
T-9398	Label Warning Money
T-9583	Time Lock labels
T-9823	KFC Decals
T-9830	Label Door 3
Y-45186	Sticker - Keep Dry
Y-45187	*Window Sticker (04045187)
Y-45188	Sticker Aviso
Y-45189	*Door Sticker (04045189)
Y-45190	Safe Sticker w/phone number (04045190)
Y-45405	Label, Protected by Timelock Safe (04045405)
Y-45407	Series 3 door sticker
Y-45408	Label, Unauthorized Service-18005289 (04045408)
Y-45410	RH Sticker Door
Y-45411	Sticker NKL (2-Hole)
Y-45417	Large Sticker, Arby's
Y-45418	Small Sticker, Arby's
Y-45420	Wendy's Timelock Sticker
Y-45424	Sticker NKL (10Hole) / LH
Y-45428	Window Stickers Churchs
Y-45483	Window Sticker Mgr Doesn't Have Key
Y-45484	Manager doesn't have key door sticker (04045484)



Y-45187



Y-45190



Y-45483



Y-45188



Y-45417



Y-45484



Y45424 NKL Premium Stickers (LH)



Y-45189



Y-45418



T-3673 Coin Stickers



Y-45410 NKL Premium Stickers (RH)

CONSUMABLES

PART #	DESCRIPTION
T-4535	Envelope Drop, Kit of Mixed Colors
T-4535-01	Envelope Drop Red
T-4535-04	Envelope Drop Green
T-4535-05	Envelope Drop Blue
T-4535-08	Envelope Drop Beige
T-4535-09	Mixed Envelopes
T-4539-09	Mixed Colors
T-800075	Envelope, Yellow
T-800076	Envelope, Blue
T-800077	Envelope, Green
Y-08001002	Customer Vinyl Envelope
Y-65141	Vinyl Envelopes
T-3723-02	Envelope 8 Col Drawer
T-7299	Amoco (MEXICO BAGS)
T-1184	Dip Stick, Auditor Autobank
T-7275	Dip Stick, Auditor Autobank for 104 Tubes
T-BT-1189	Dip Stick, D8 Autobank
T-4769	Money Tube, Clear w/Cap, Auditor Autobank
T-600131	Money Tube, D8 Autobank
T-16000039	Magnetic Tube Rack for D8 Tubes
T-7240	White Spiral Wrap
T-4711	Paper Roll 3" x 3 1/8"
T-4692	Ribbon Blk F/Epson 26
T-9997	Replacement Printer Ribbon (Epson Receipt Printer)
Y-45012	Grout Kit



T-16000039
Tube Rack



Y-45012 Grout Kit



T-4535 Cash Envelopes



Y-65141 Large
Cash Envelopes



T-9997 Printer Ribbon



T-4769 Clear Coin Tube



T-1184 Dip Stick

UPGRADE KITS

PART #	DESCRIPTION
T-15020010	<u>AuditLok XL Upgrade Kit</u>
T-15020100	AuditLok XL Inner Board
T-15020200	AuditLok XL Outer Board
T-15020700	Communication Cable, 42"
T-15021300	Peizo Alarm
T-15020900	Battery Pack, 8 Vdc
T-15000217	Triple Output Power Supply 5V,±12V
T-15020310	Power Cable
T-15020950	Battery Board
T-15020960	Battery Jumper: Battery Board to Outer Board
T-15020610	Alarm External Cable, 36"
T-15021100	Serial Cable
T-15000023	Outer Door Closure Sensor Assembly
T-15021807	Outer Door Lock Cable
T-15013000	Outer Door Lock, Swingbolt, RS/LH
T-15014000	Inner Door Lock Cable
T-15011000	Inner Door Lock, Springlock
T-10000076	Jack Clip
T-10000065	Connector Plate Assembly
	<i>Kit includes 6 keys; specify customer info for key and inner board setup</i>
T-4397	<u>Vindicator 2 Upgrade Kit</u>
T-15082000	Outer Board
T-15081000	Inner Board
T-15083500	Communication Cable
T-15083000	Transformer, 16.5 Vac
T-15084000	Transformer Cable
T-15084006	Printer Cable
T-15099541	Outer Lock, Swingbolt, LH/RS
T-9390	Outer Lock Cable
T-9349	Inner Lock, Springbolt
T-9391	Inner Lock Cable
T-15003007	Magnetic Door Sensor
T-15105170	<u>IQ to Auditor New Upgrade Kit</u>
T-15099550	CPU Board
T-15099551	Driver Board
T-15099552	Display Board
T-1209	Printer Cable
T-1033	Door Lock Harness
T-1037	Display Cable
T-15094521	Sensor Board
T-4720	Door Keyswitch (qty 2)
T-4701	Door Sensor
T-9988	Printer Adapter
T-9995	Serial Receipt Printer
T-4624	End Cover
T-9873	Plastic Standoffs (qty 4)
HS100	Screws, 8-40 Phillips
T-15105170-1	<u>IQ to Auditor Upgrade Kit, Without Printer</u> Same as T-15105170, minus T-9995 and T-9988
Y-45157	<u>TimeLok XL Electronics Kit</u> Includes inner and outer boards, communication cable, transformer, mouser, locks and lock cables.

Fire King®

SECURITY PRODUCTS
FOR THE 21ST CENTURY

Fax Cover Sheet

PARTS ORDER FORM ATTENTION PARTS DEPARTMENT

PART #	DESCRIPTION	QTY	\$ UNIT	\$ EXTENDED
SHIPPING & HANDLING	<input type="checkbox"/> Ground <5 lbs: \$8.00 <input type="checkbox"/> 2nd Day <5 lbs: \$15.00 <input type="checkbox"/> Next Day <5 lbs: \$30.00 <input type="checkbox"/> Saturday: Add \$10.00	<input type="checkbox"/> Ground 5-10 lbs: \$10.00 <input type="checkbox"/> 2nd Day 5-10 lbs: \$20.00 <input type="checkbox"/> Next Day 5-10 lbs: \$44.00 <input type="checkbox"/> Other:		
\$ TOTAL				

Ordered By _____

Bill To Company _____

Bill To Address _____

Ship To Company _____

Ship To Address _____

Contact Phone _____

Contact Fax _____

Visa MasterCard Discover AMEX
 Card # _____

Expires _____

Name on Card _____

NOTICE: You must indicate shipping and handling charges. Sales Tax (Indiana, or where otherwise required by law) will be added to your total.

After copying and filling out this form, fax it 1-800-227-7513.
To confirm or check order status, call our Parts Department at 1-800-528-9900, ext. 611.